



THE INDUSTRY LEADER

L.A.I. Group has over thirty years of experience producing and delivering high quality security products. On the following pages you will find one of the largest arrays of cam locks, padlocks, specialty locks and security hardware in the world. This catalog contains L.A.I.'s Standard Hardware and Accessories. If you don't find what you need, call us toll-free. We have many other non-standard pieces in inventory, and can custom fabricate for you right in our Southern California facility.

Before ordering, please take a minute to review these guidelines:

Locks:

- Specify type: ✓ Cam Type
- ✓ Padlock

For Keyed Alike Locks:

Specify if you want to maintain an existing key code series or start a new one.

If you want to match locks from another manufacturer, specify the brand and model. Usually we can match Fort, ACE, ESD, Baton and many others.

Hasps:

We provide hasps for all L.A.I. Padlocks. Some hasps may require some minor installation modifications. All L.A.I. hasps will accommodate any size padlock with shackle diameter of 9/16" or less.

See. L.A.I.'s security hardware catalog for specifics.

Cams:

Please refer to the chart on page 9 for a complete guide to cams in the catalog. If you do not see what you need, call us. We can manufacture a custom piece to your specifications. Minimum quantities may be required for custom orders.

ACCESSORY CATALOG

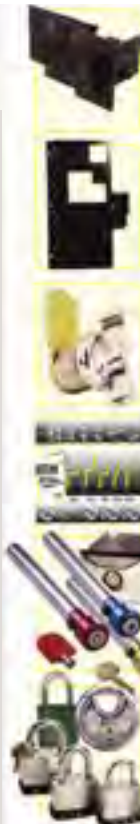

High Security Hasps 1-3

Security Accessories for Amusement
and Coin Op..... 4-7

Bulk Vending Locks Economy Camlocks
Thumbturns & Keyless Camlocks 8

Cams & Accessories - Ordering Guide. 9

Newspaper Vending Security Locks
and Coin Laundry Boxes 10-11

Padlocks 12-13

Lock America International, Inc.

dba. L.A.I. Group
9168 Stellar Court
Corona, California 92883

Tel: 951.277.5180

Fax: 951.277.5170

Toll Free: 800.422.2866

Toll Free Fax: 888.422.2866

Website: <http://www.laigroup.com>

E-Mail: sales@laigroup.com

Offices are located in:
California • Massachusetts • Mexico
Australia • Taiwan • United Kingdom

Lock America's Warranty

L.A.I. Group warrants, to the original purchaser, that all of its locks will be free of manufacturing defects (changes in appearance due to oxidation or normal discoloration excluded) for a period of 7 (seven) years from the date of purchase. L.A.I. Group will not assume any liability for an consequential loss or damages.

ACCESSORY CATALOG



Welded Top Cover to help prevent bending.

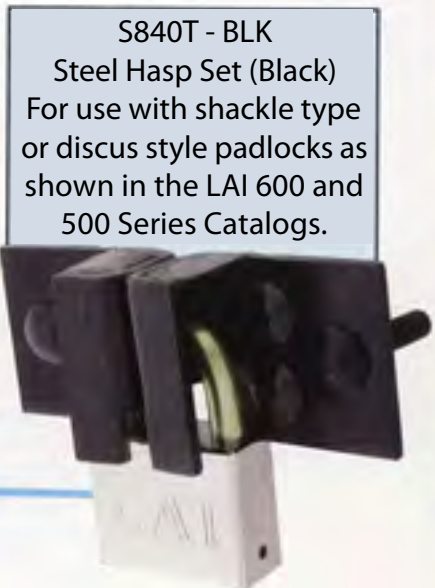

S840T - BLK
Steel Hasp Set (Black)
For use with shackle type
or discus style padlocks as
shown in the LAI 600 and
500 Series Catalogs.

Shrouded to protect
padlock shackles
from bolt cutter attacks.

Center Hole for use with
Lock America's "F" model
Millennium Locks.



S820T-A535 - Steel Hasp Set
Set Shown with patented LAI
Millennium Lock featured in
the LAI 600 Series Catalog.



S828S-21
Hardened
Steel Shackle
Guard with
S820T-A535
Hasp and B645A
Padlock Attached

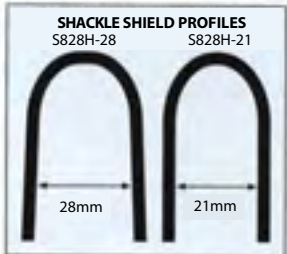
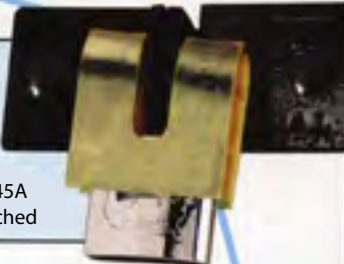

S828S-28
Hardened Steel
Shackle Guard



S828S-21
Hardened Steel
Shackle Guard



S828S-28
Hardened
Steel Shackle
Guard with
S820T-A535
Hasp and B645A
Padlock Attached



Shown with optional carriage bolt cover



S869H - Hasp Set
With Shroud Protection
and Patented Millennium
Lock as seen in the LAI 600 Series Catalog.

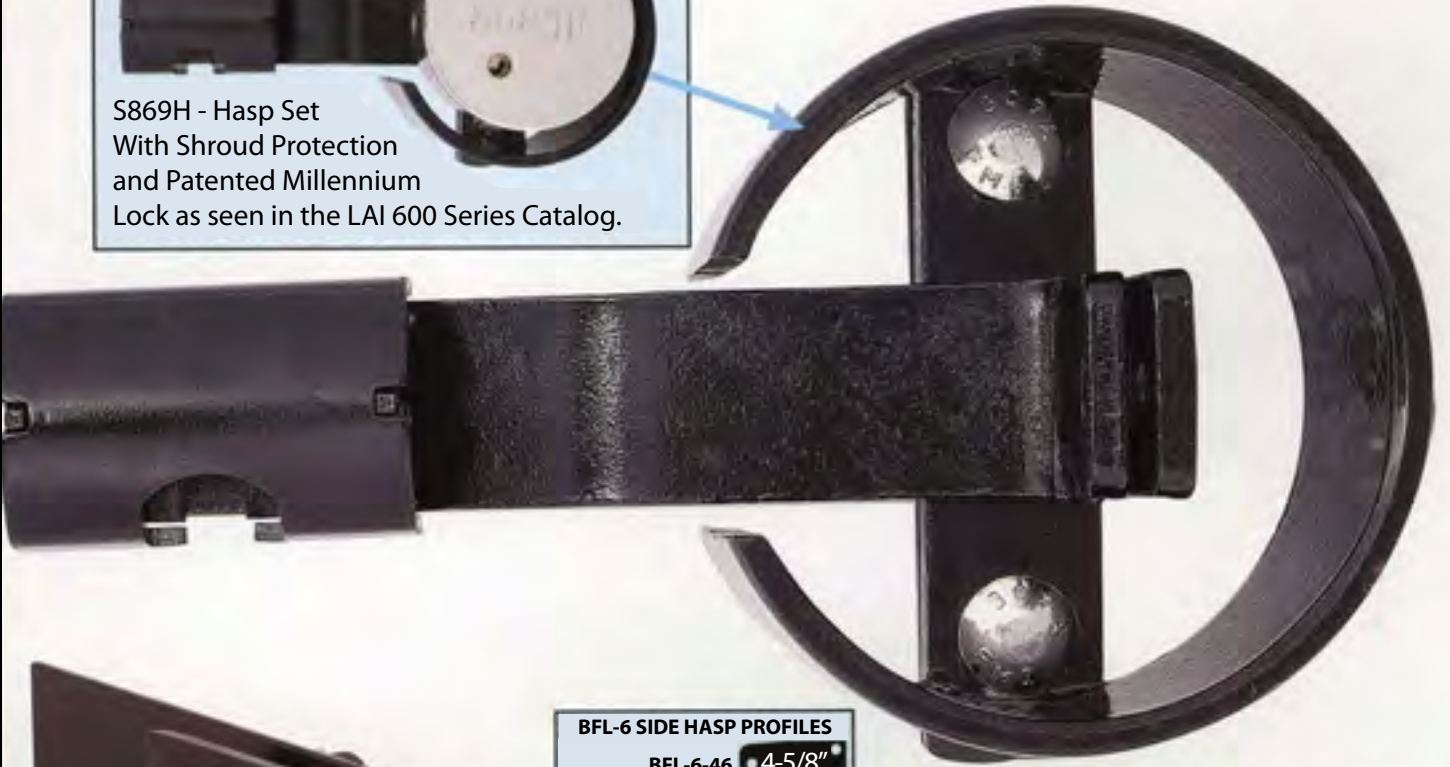

BFL-6 SIDE HASP PROFILES

- BFL-6-46 • 4-5/8"
- BFL-6-46-7 • 7"
- BFL-6-46-13 • 13"

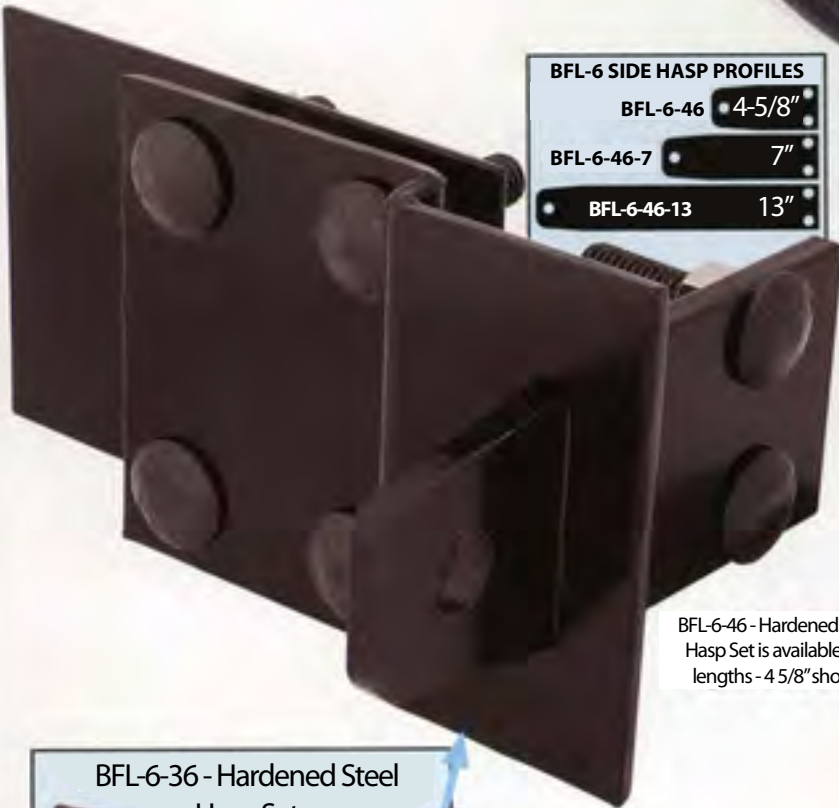

BFL-6-46 - Hardened Steel
Hasp Set is available in 3
lengths - 4 5/8" shown



BFL-6-36 - Hardened Steel
Hasp Set



Made to be used
with "A" Style Locks Only.
See 600 Series Lock Catalog.



S820T - Hasp Set
(special application)
Accommodates Puck Style Locks
Featured in the LAI 600
Series Catalog.



Optional Carriage Bolt Cover

S868H-BL - Hasp Set

S868H-BL is designed to fit all Dixie Narco/Royal Vendor/Vendo and other machines.



S868H-MH Mounting Hardware *Sold Separate



S868H-CC** Hardened Steel Hardware Cover *Sold Separate - Designed to be used with all of these LAI Hasps

**Patent Pending - S868H-CC



Different Profiles to Accommodate Most Manufacturers

Please specify machine type

S868R

Universal Fit

S868H

S868D



S868H-PC Hasp Set With Padlock Cover

**Made to use with Shackle style Padlocks



S819N-KS
Security Bar For
Pinball Machines
(Large Door)

Designed to
protect padlocks
from being cut

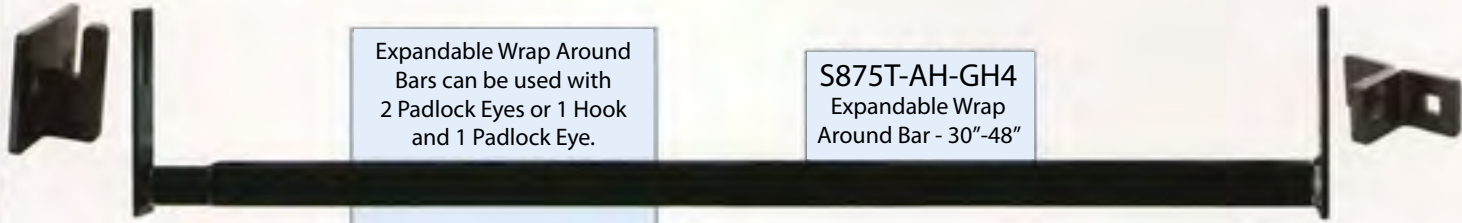

Expandable Wrap Around
Bars can be used with
2 Padlock Eyes or 1 Hook
and 1 Padlock Eye.

S875T-AH-GH4
Expandable Wrap
Around Bar - 30"-48"

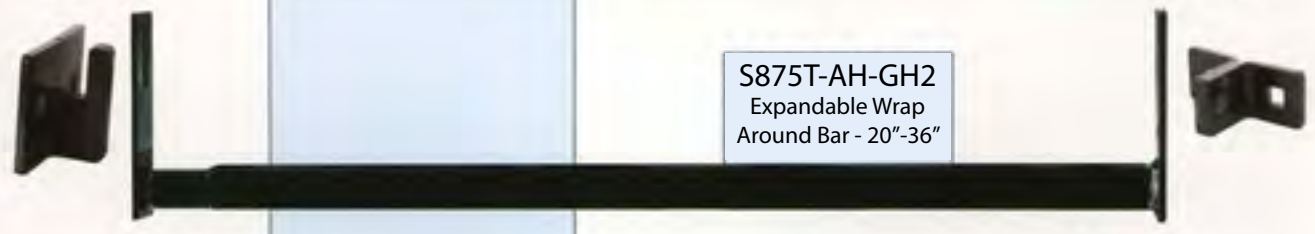

S875T-AH-GH2
Expandable Wrap
Around Bar - 20"-36"

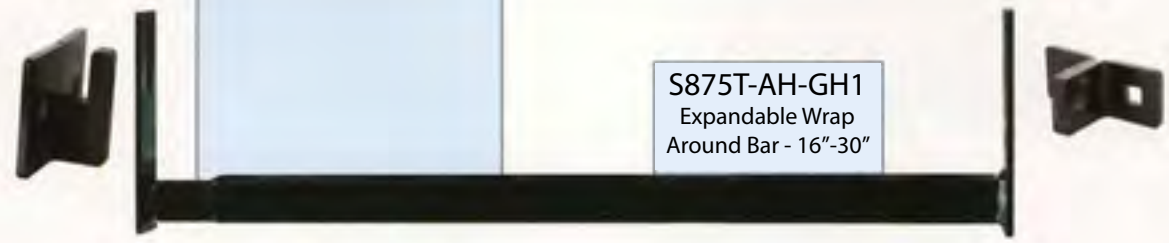

S875T-AH-GH1
Expandable Wrap
Around Bar - 16"-30"



S807T
4-1/2" Bar with Padlock
Protector - Can
Mount with Standard
Hardware or Camlock
as shown at right.



S819H
Original Double
Door Bar



S807T-PGD
Panel Guard
narrow opening



S807T-PGDW
Panel Guard
wide opening



S801T
Standard 12' Bar



S802T
Standard 16' Bar



S803T
Standard 24' Bar

Lock America measures primarily in millimeters (1" = 25.4mm) • All locks shown at approximate actual size.



SECURITY ACCESSORIES FOR AMUSEMENT AND COIN OP

S819X-BV
Full Metal Jacket
With Cutout For
Bill Validator

Designed for use
with padlocks
and shrouded to
prevent cutting.

Welded to prevent
bending. 

S819X
Full Metal Jacket Ultimate
Double Door Bar
(Shown with optional B645B
Padlock featured in the
LAI 600 Series Catalog.)

Pre-Threaded
Backing Plate
included

Pre-Threaded
Backing Plate
included

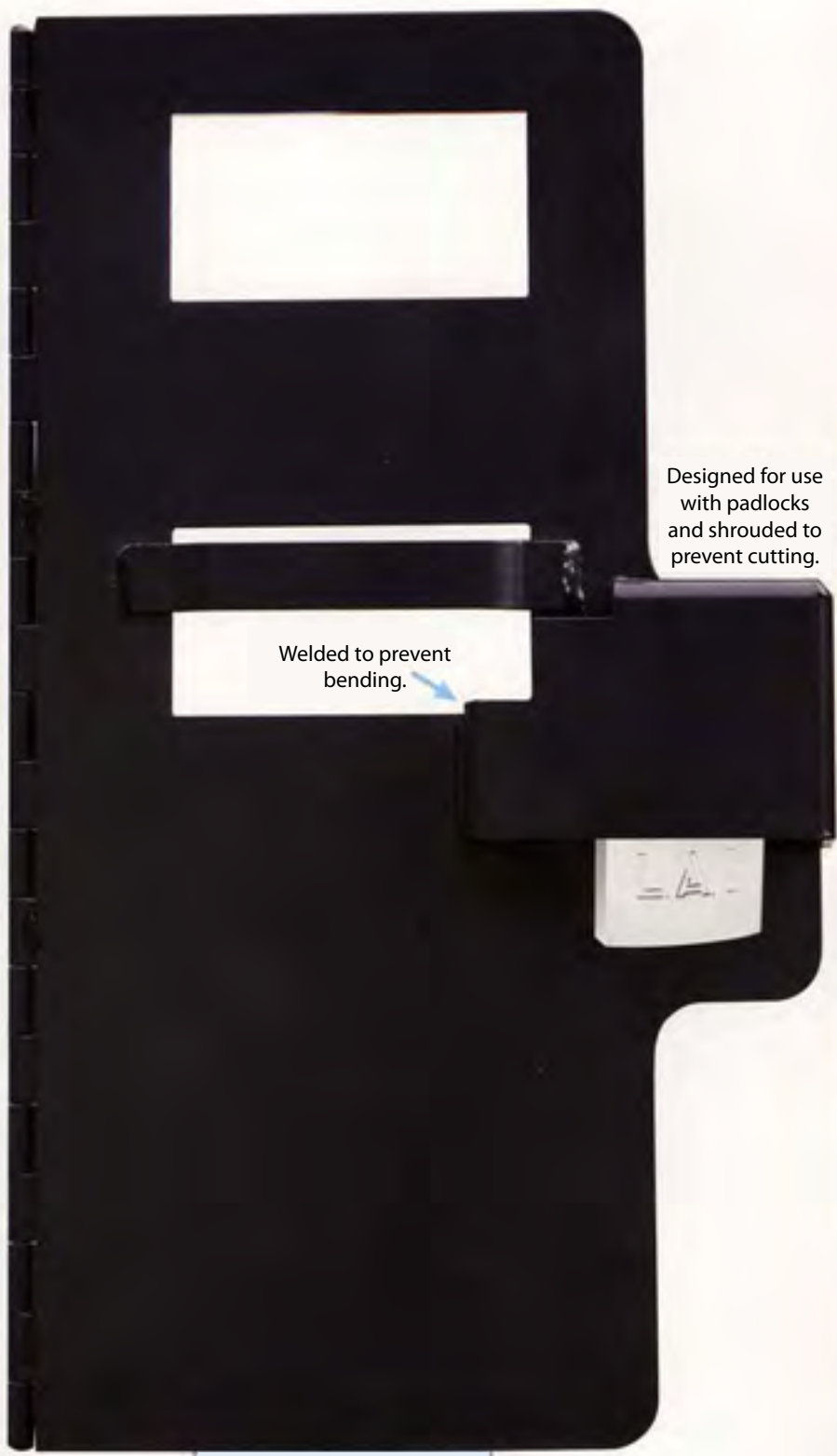



Pre-Threaded
Backing Plate
included



S819X-2000
Full Metal Jacket Ultimate Double Door Bar Designed
to Accommodate Puck style locks. Shown with
Millennium Lock as soon in the LAI Series 600 Catalog.



Z427G-A0
Original Style Bulk Vending Lock



Z428P-OH
Housing for use with Z427, B527G and Z437 bulk vending locks



Z437N-A0
NEW Slotted Dimple Key Bulk Vending Lock with Two Rails - Standard Design

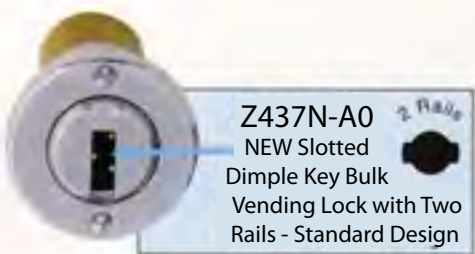

Z437G-A0
Original Style Dimple Key Bulk Vending Lock with Two rails - Standard Design



Z431N-A0
NEW - Slotted Dimple Key Bulk Vending Lock with Larger Diameter Four Rail Design for Special Machine applications.



Cut Dimple Key
Z437G-CK for Z437G Lock
Z413N-CK for Z413N Lock



Z427G-CK
Cut Key for Z427G Lock



B527G
Tubular Style Drop-In Lock for Bulk Vending Machines with Two Rails Standard Design



Z122G - 7/8" - (22mm)
Thumbturn Camlock

Not shown
Z122G-RI-7/8" (22mm)
Slotted Front Camlock



Z431G-A0
Original Style Dimple Key Bulk Vending Lock with Larger Diameter Four Rail Design for Special Machine applications.

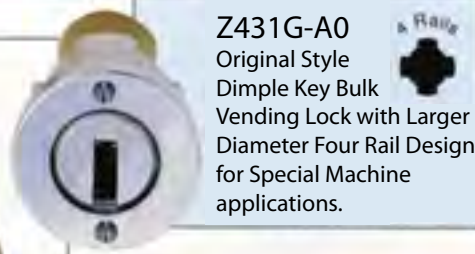

Z118G - 5/8" - (18mm)
Thumbturn Camlock
Z118S-RT - 5/8" (18mm)
Thumbturn Camlock with Standard Tail Piece

Not Shown
Z118S - 5/8" - (18mm)
Slotted Front Camlock with Standard Tail Piece - Special Order
Z118G-RI - 5/8" (18mm) Slotted Front Camlock with Standard Tail Piece - Special Order

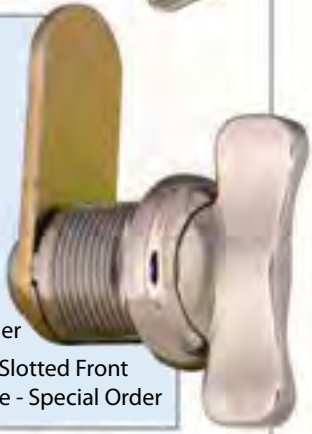

400 Series
Economy Camlock and Cut Keys



Z400D-CK
Cut Keys for all 400 series camlocks

Z418D-AI-D2 - 5/8" - (18mm)
Economy Camlock - Available Keyed Alike or Keyed Different - Side View Comes with Standard Tail Piece.



Z422D-AI-D2 - 7/8" - (22mm)
Economy Camlock Available Keyed Alike or Keyed Different - Side View Comes with Standard Tail Piece.



Z430D-AI-D2 - 1-1/8" - (30mm)
Economy Camlock Available Keyed Alike or Keyed Different - Side View Comes with Standard Tail Piece.



Z130G - 1-1/8" - (30mm)
Thumbturn Camlock
Z130G-RT - 1-1/8" (30mm)
Thumbturn Camlock with T-Shaped Handle
Z130S-RT - 1-1/8" - (30mm)
Thumbturn Camlock with Standard Tail Piece



All of the Thumbturns and Z400 Camlocks shown on this page come with Standard Tail Pieces and can be used with Standard Cams.



S9245-F, S9285-F, S9305-F, S9345-F, S9445-F, S9505-F S9325-FP2 S9255-FCH S9365-FP1 S9215-FH S9495-B12 S9275-B6

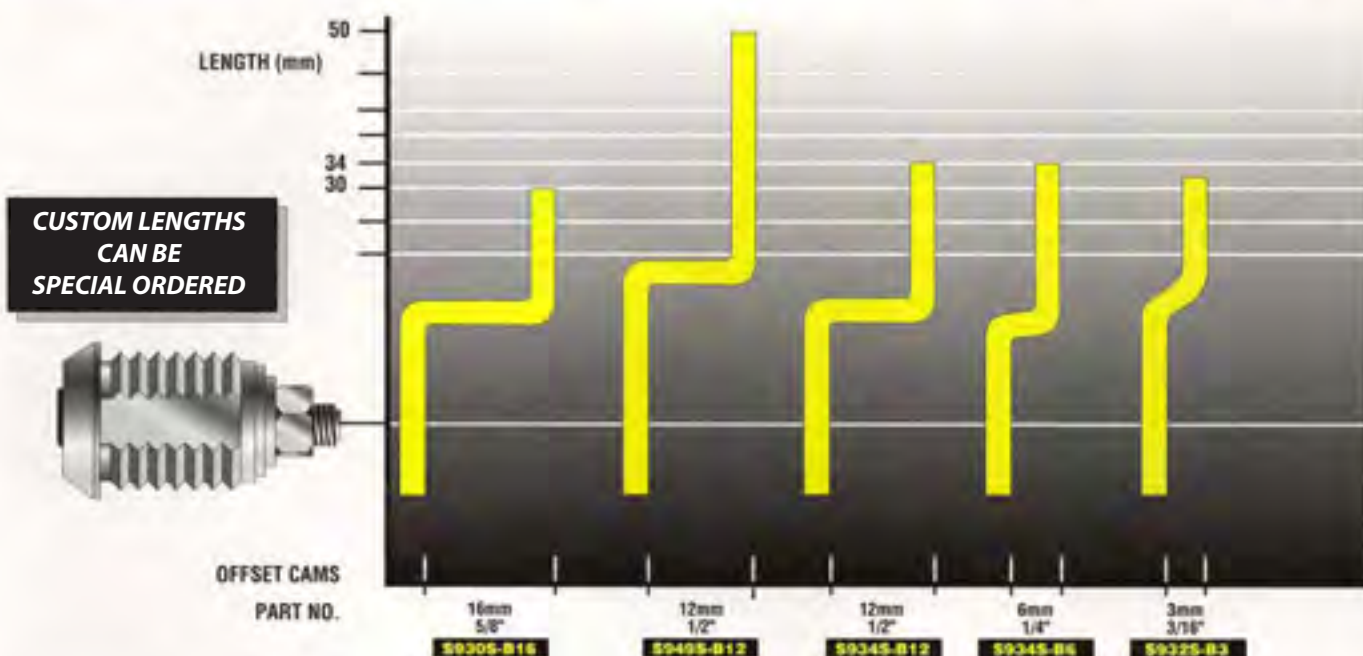

**CUSTOM LENGTHS
CAN BE
SPECIAL ORDERED**



OFFSET CAMS
PART NO.



S8215 S8235 S8245 S8225 S8255-H5 S8265

PART NO.	OUTER DIAMETER	INNER DIAMETER	HEIGHT	FLATS	MATERIAL	FINISH
S8215	1-1/8"	3/4"	1/8"	2	Steel	Nickel
S8235	1-1/16"	3/4"	1/8"	0	Steel	Nickel
S8245	7/8"	3/4"	1/8"	0	Steel	Nickel
S8225	1-1/8"	3/4"	1-1/16"	2	Steel	Nickel
S8255-H5	1-3/16"	3/4"	1/4"	0	Hardened Steel	Chrome
S8265	1-3/16"	3/4"	3/8"	0	Brass	Chrome

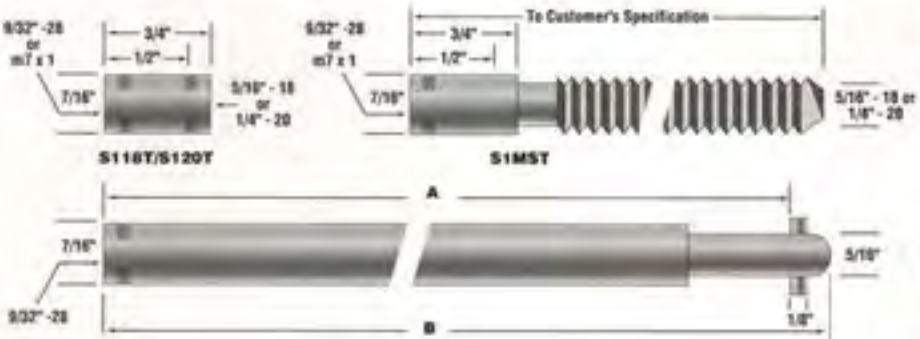

PART NO.	"A" DIMENSION	"B" DIMENSION
S112T	4-3/4"	5"
S121T	8-3/16"	8-7/16"
S130T	11-1/2"	11-5/8"
(See Insert)	12-5/16"	13-5/8"

**Shaft can be used
for both lengths.**



S130T (11-1/2" OR 12-5/16")



Extended Length allows You To Double Lock

A626L
High Security Bolt Lock
Shown with Optional Hardened
Steel Security Collar
Available in Blue, Gold or Raspberry



B645B
High Security Padlock
with Boron Alloy
Shackle - featured in the
600 Series Catalog

High Security Bolt Lock also
available in 500 Series Tubular Lock



S836H



A526F
Original Raspberry
Bolt Lock with
500 Series Tubular Key
Lock - Also Available in
Gold and Blue



A626F
Original Blue
High Security
Bolt Lock - Also
Available in
Raspberry



N613K
600 Series
High
Security Key



S502K
Tubular Keys
Available with Color
Keybows as Shown Below



**Color
Keybows**
Color keybows
allow for fast
and easy
identification of
N613K keys.



A626F
Original Gold - High
Security Bolt Lock

**Color
Keybows**
Color keybows
allow for fast and
easy identification
of S502K
keys.



S102V
Oversized Coin
Laundry Box
7.0" Long
3.5" Wide
3.24" Deep



S100V
Standard Coin
Laundry Box
5.75" Long
3.5" Wide
2.5" Deep



All coin vaults available with your choice of either High-Security LAI 600 Series Locks or the LAI 500 Series Tubular Locks.

S112T with B518G
4-3/4" - 90° Turn Shaft - Shown with
Optional Tubular Camlock Available in
the LAI 500 Series Catalog.



S112T 4-3/4" - 90° Turn Shaft
S121T 8.16" - 90° Turn Shaft
S125T 10" - 90° Turn Shaft
S129T 11.63" - 90° Turn Shaft
S131T 12-1/4" - 90° Turn Shaft

S112T with B618B
4-3/4" - 90° Turn Shaft - Shown with
Optional High-Security Camlock
Available in the LAI 600 Series Catalog.



Custom length shafts available - Tell us your requirements



Camlock Screwshafts
Made to Customer's
Speciycation's - Please Refer
to Page 9 for Assistance.



(Meets NAMA speciycations)
**Shaft is sold separately
please specify length

C865H-090
C832H-090
Quarter Turn T-Handle
available in Two sizes
with a black or chrome
ynish - See Series 500 and
600 catalogs for all
options.

T-Handle Threaded Screw Shafts
For use with T-Handles

- A. C865H-T056 - 2-1/4" - 56mm
- B. C865H-T070 - 2-3/4" - 70mm
for use with quarter turn only
- C. C865H-T069 - 2-11/16" - 69mm
- D. C865H-T104 - 4 - 5/32" - 104mm
- E. C865H - T124 - 4-7/8" - 124mm
- F. C865H-T164 - 6-17/16" - 164mm

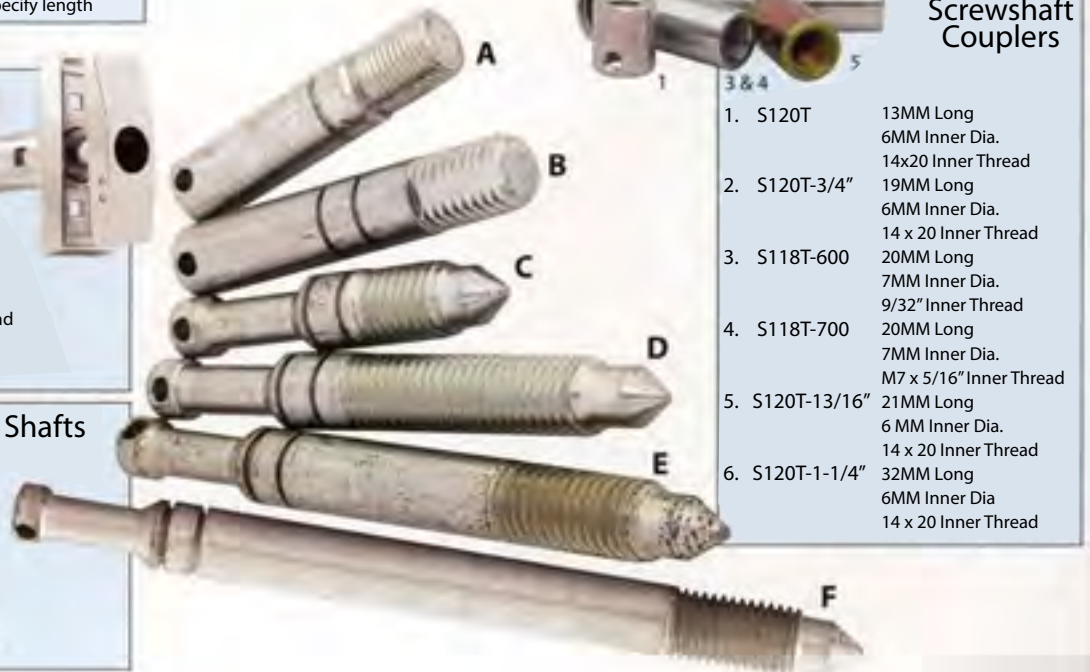

Screwshaft Couplers

- | | |
|-----------------|--|
| 1. S120T | 13MM Long
6MM Inner Dia.
14x20 Inner Thread |
| 2. S120T-3/4" | 19MM Long
6MM Inner Dia.
14 x 20 Inner Thread |
| 3. S118T-600 | 20MM Long
7MM Inner Dia.
9/32" Inner Thread |
| 4. S118T-700 | 20MM Long
7MM Inner Dia.
M7 x 5/16" Inner Thread |
| 5. S120T-13/16" | 21MM Long
6 MM Inner Dia.
14 x 20 Inner Thread |
| 6. S120T-1-1/4" | 32MM Long
6MM Inner Dia
14 x 20 Inner Thread |



A740N-A0-Color
1-5/8" - 40mm
Easily Re-Keyable Zimag
Padlocks with Chrome
Shackles

**COMING
SOON**

**50mm
Size**

A740N-IC-Inner Core
Assembled in California. Can
be assembled to the B745C
Key Codes and some other
companies key codes.



B745C-CK - Cut Key



B435B-AI
Solid Brass Bodies
and Chrome Plated
Brass Shackles O'er
the Ultimate in Rust
Prevention - All yve
colors are keyed alike.

S780R - AI-RED
Diameter:
3-1/8"
(80mm)



Super Yellow, Big Red Green Monster and Big Blue - Heavy Duty,
keyed alike, disk locks.
All four colors
keyed alike
Diameter:
2-3/4"
(y0mm)



**S770R - AI
Color**

B750X-A1 - 50mm
B745C-A1 - 45mm
 Solid Brass Padlocks



- Hardened steel shackles.
- Solid brass body for maximum rust resistance.
- Double locking heel and toe latch mechanism.
- Hundreds of keyed-alike systems available.
- B745C Can be keyed alike to A740c padlocks.
- Yale security keyway.
- Red warning label permanently stamped onto body.
- May be keyable to some other manufacturer's locks.

S770R-DK6-KA

Diameter:2-3/4"(70mm)
 Dimple Key, Keyed Alike
 Disk Lock - dimples resist sticking and breaking.

These disk locks feature Stainless Steel Bodies to resist rust and Hardened Shackles for added security



S770R-A1

Diameter:2-3/4"(70mm)

L750J-A1
L745J-A1
L740J-A1
L730J-A1
 Laminated Steel Padlocks



- Hardened steel shackles.
- Zinc-plated laminated steel body to resist rust
- Double locking heel and toe latch mechanism.
- Many keyed-alike systems available.
- The three largest sizes can be keyed to the same combination and also to some other manufacturers' key codes.
- Different sizes may be keyed alike.
- Variety of security keyways available.

B440D-AI - 40mm
B430D-AI - 30mm
 Solid Brass Economy Keyed Alike Padlocks

- WARNING permanently stamped into 40mm padlock
- Hardened steel shackle.
- Solid brass body.



B425D-AI - 25mm
 Solid Brass Economy Keyed Alike Padlocks
 • Hardened steel shackle.
 • Solid brass body.